

This project, like most OpeningDesign's projects, is open source. (Attribution-ShareAlike 4.0 International--CC BY-SA 4.0)--freely available to any party for future use, assuming the terms such as Attribution and ShareAlike are honored.

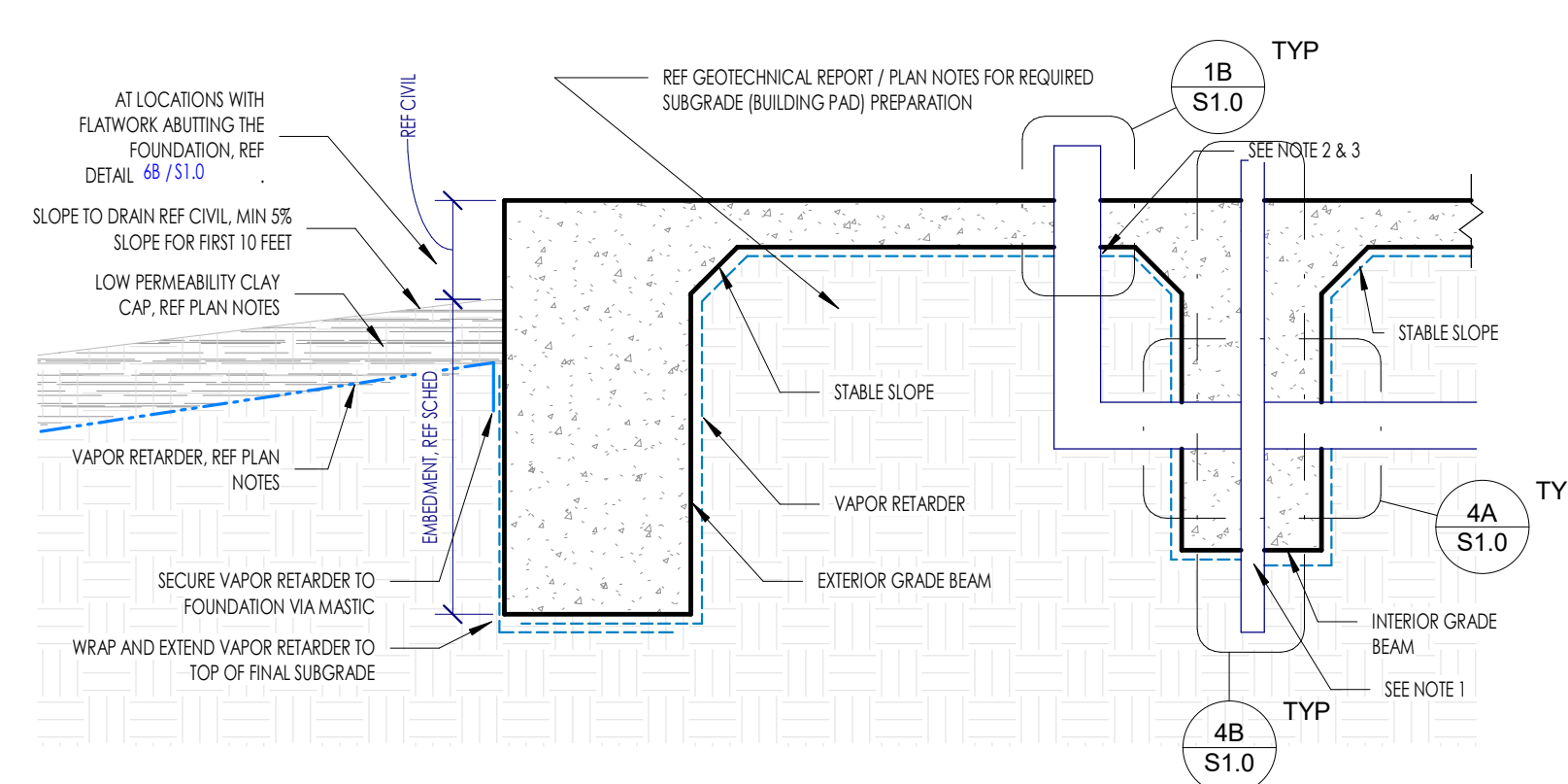

4D TYPICAL SUBGRADE AND VAPOR RETARDER PREPARATION
NOT TO SCALE

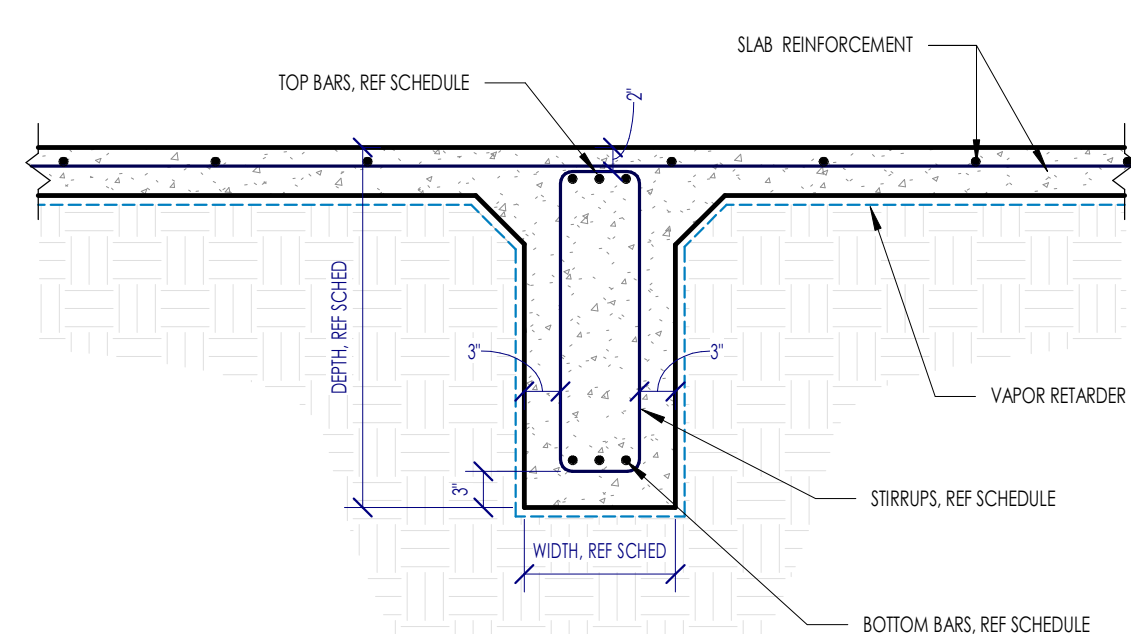

2D TYPICAL INTERIOR GRADE BEAM
NOT TO SCALE

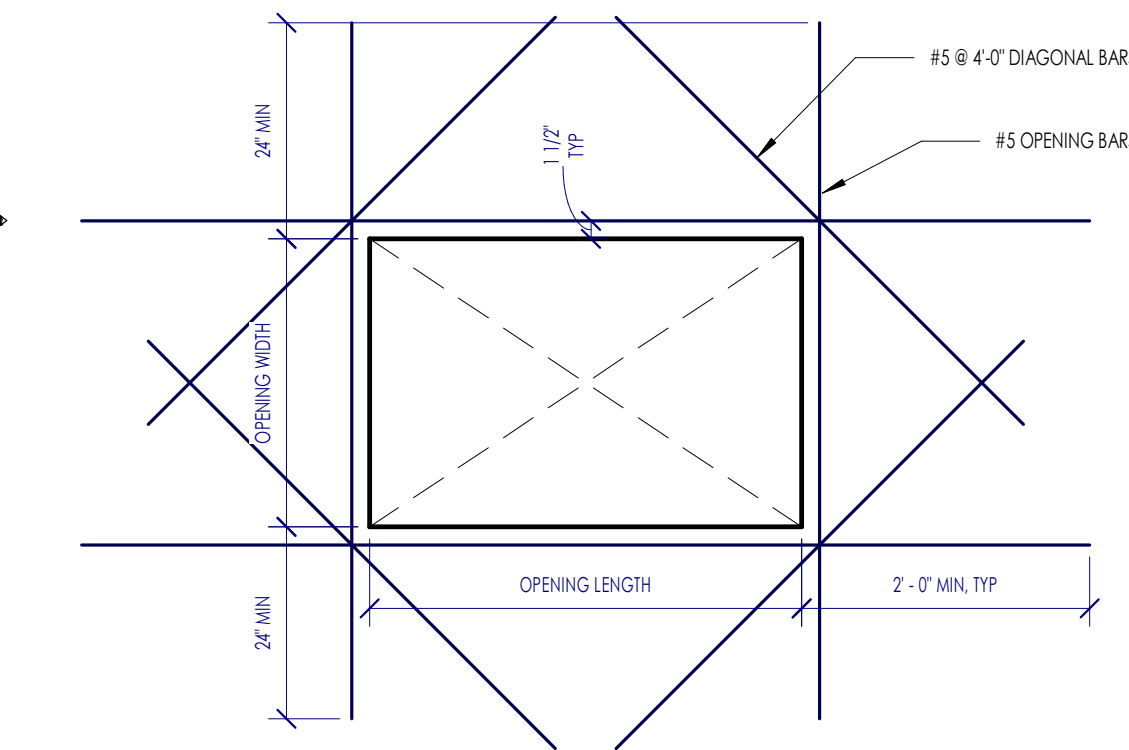

1D TYPICAL REINFORCEMENT AT SLAB BLOCKOUT
NOT TO SCALE

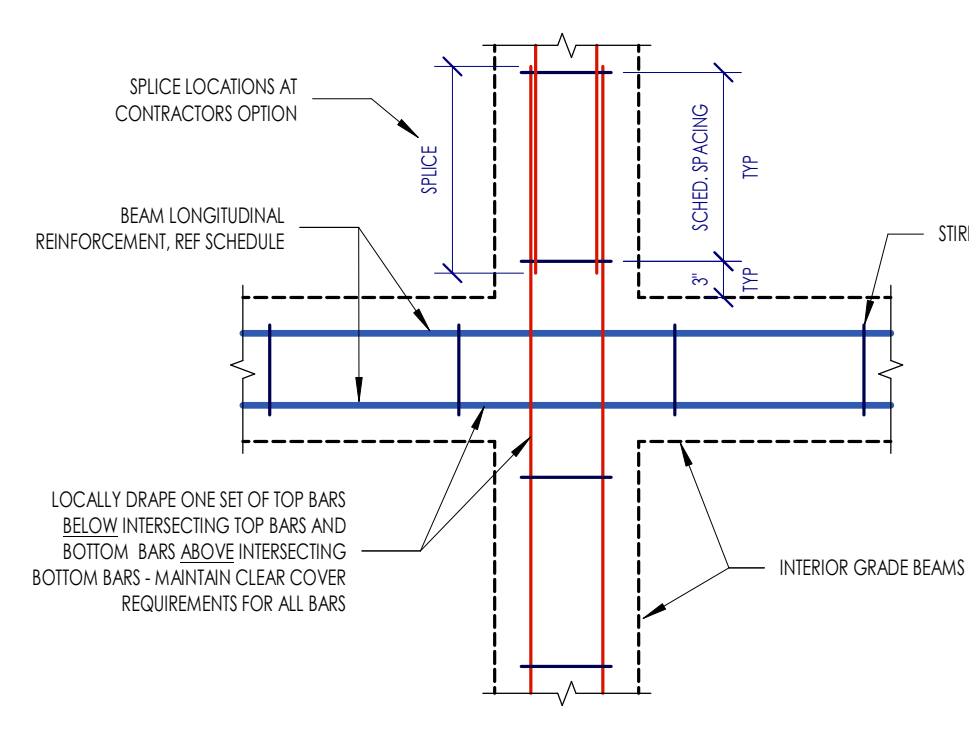

6C TYPICAL INTERIOR BEAM INTERSECTION
NOT TO SCALE

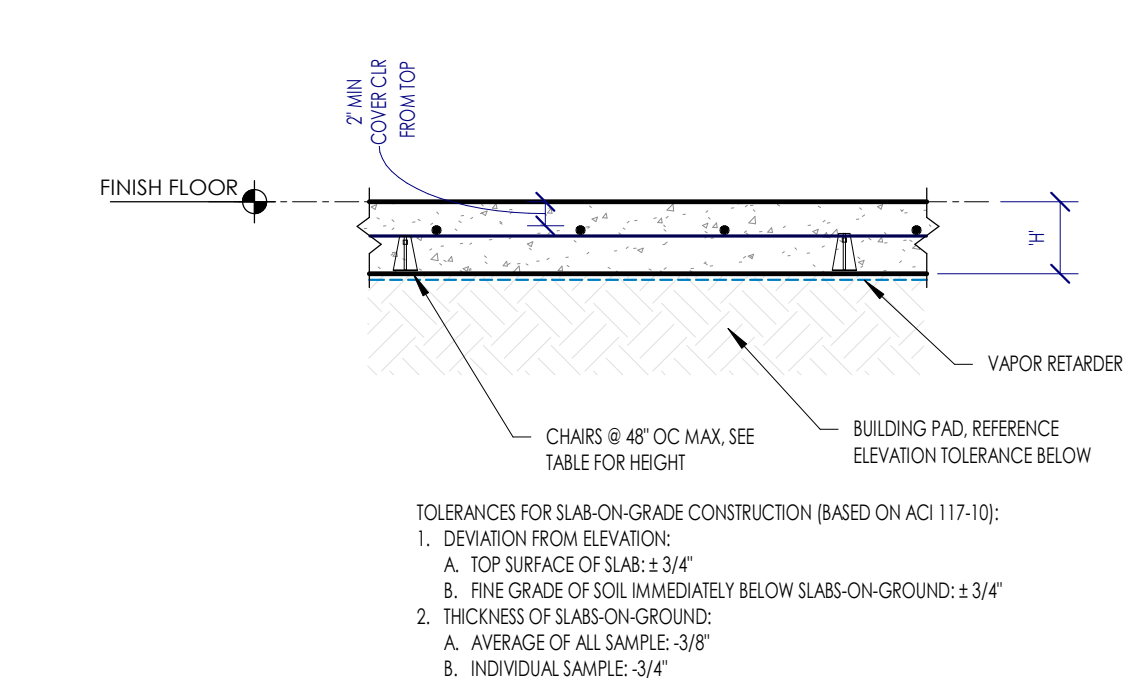

5C TYPICAL SLAB-ON-GRADE SECTION
NOT TO SCALE

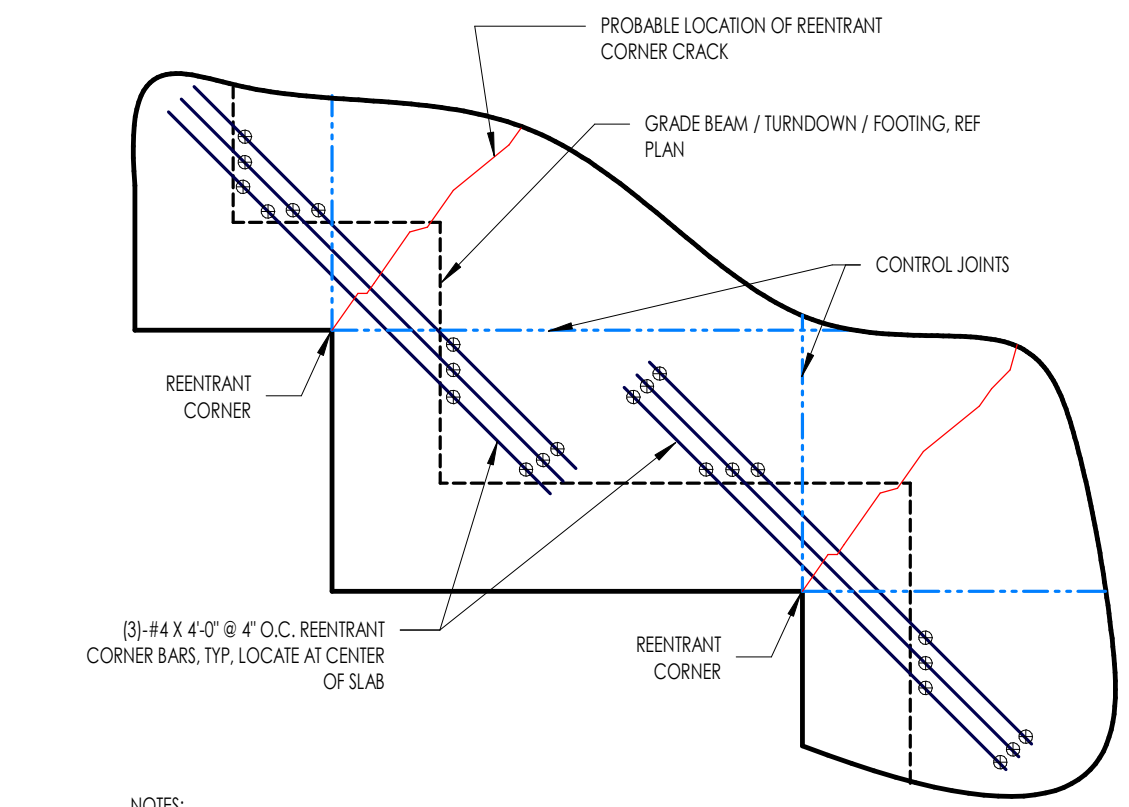

4C TYPICAL REINTEGRANT CORNER BARS
NOT TO SCALE

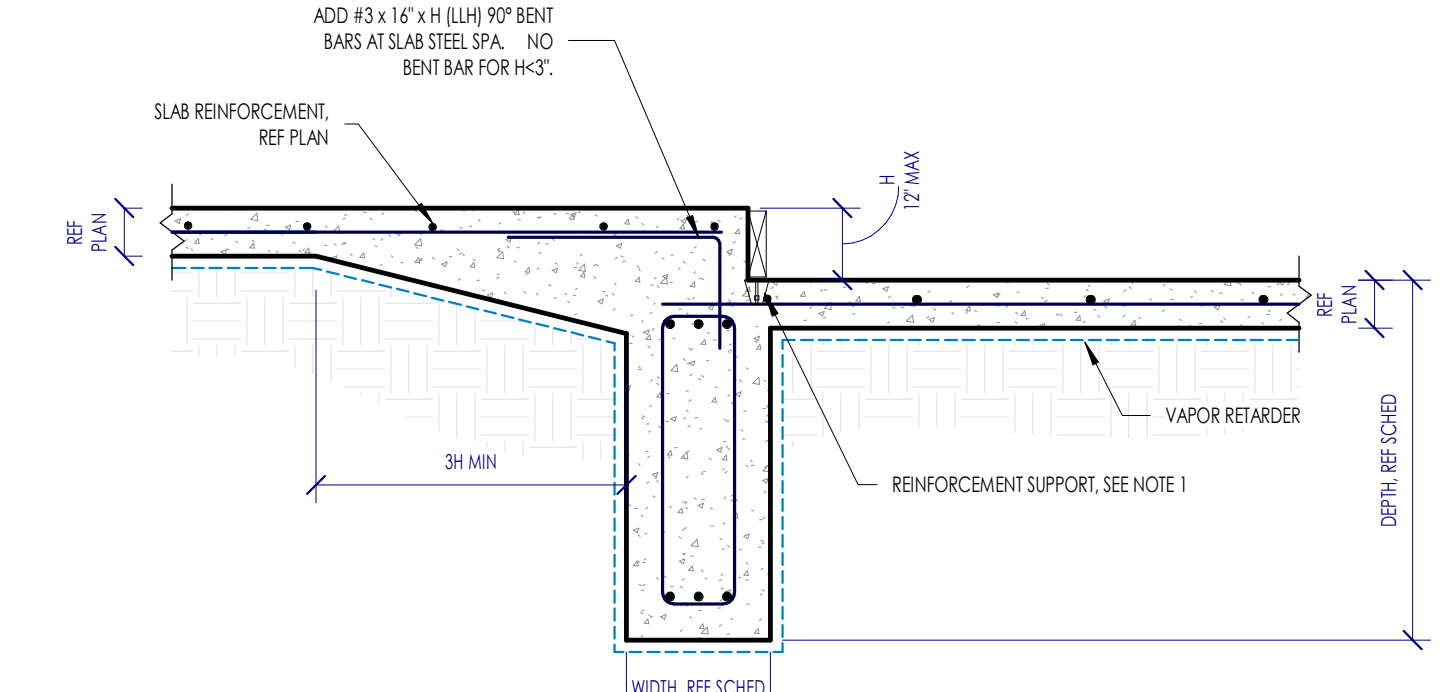

3C TYPICAL SLAB DROP AT GRADE BEAM
NOT TO SCALE

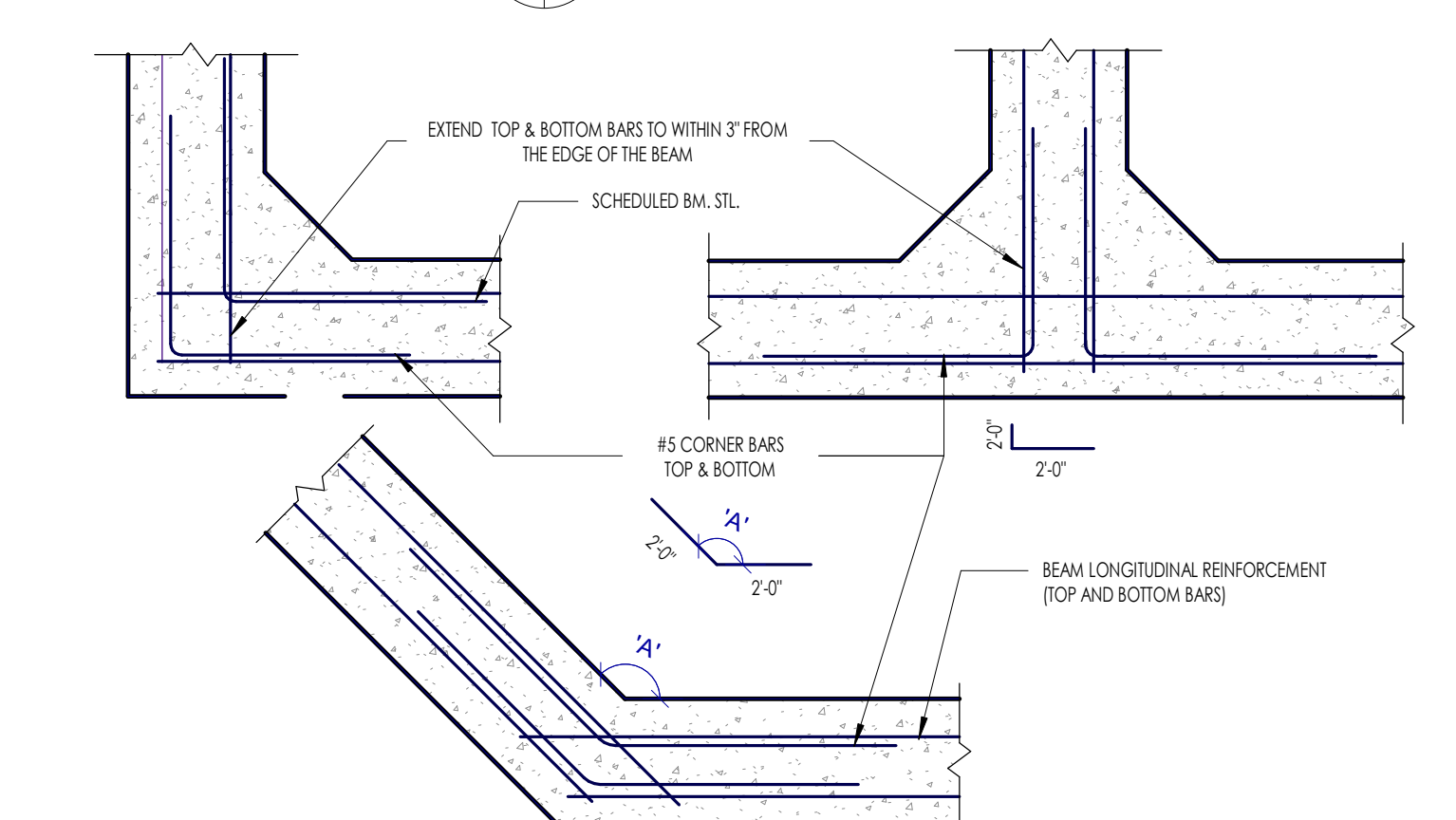

1C TYPICAL CORNER BARS
NOT TO SCALE

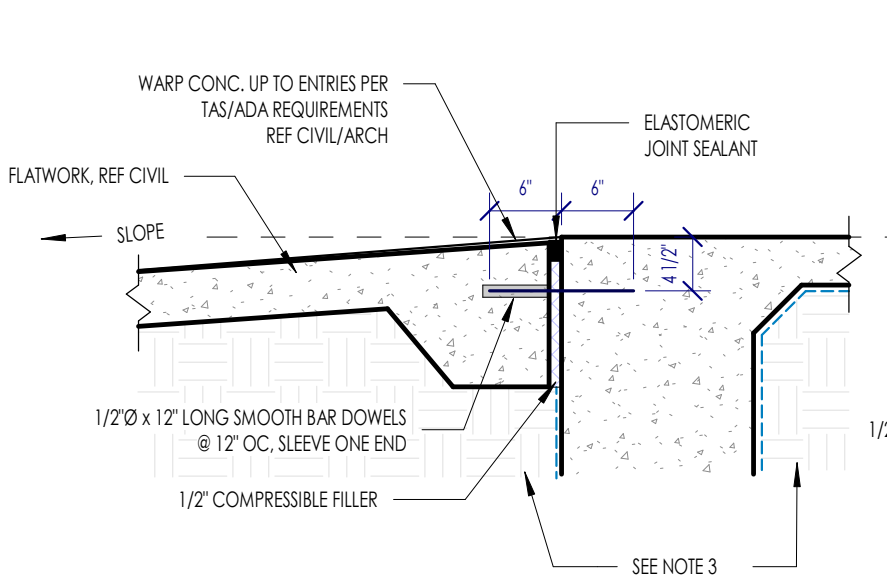

6B FLATWORK AT ENTRY DOOR
NOT TO SCALE

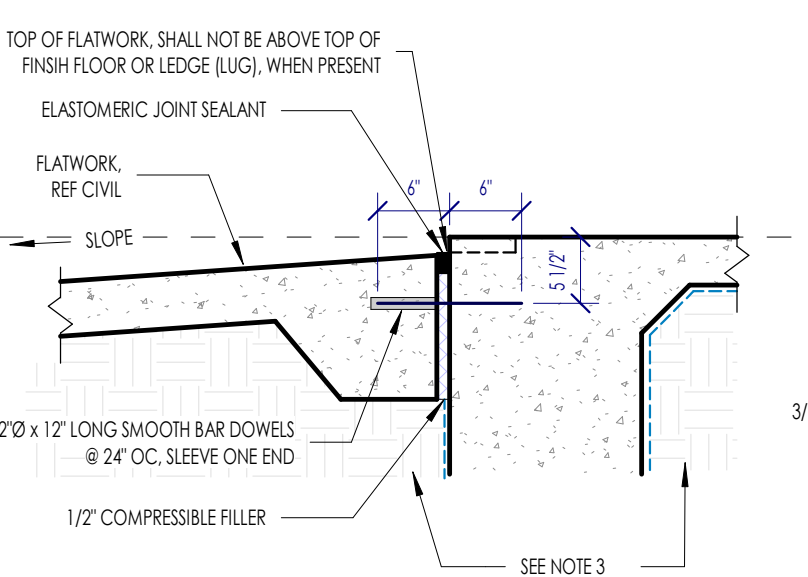

6B FLATWORK NOT AT ENTRY DOOR
NOT TO SCALE

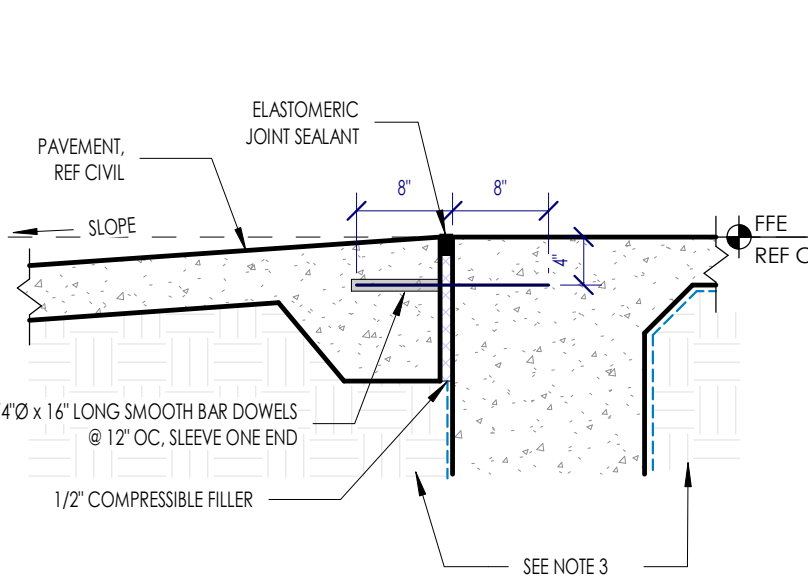

6B AT PAVEMENT (DRIVE-IN)
NOT TO SCALE

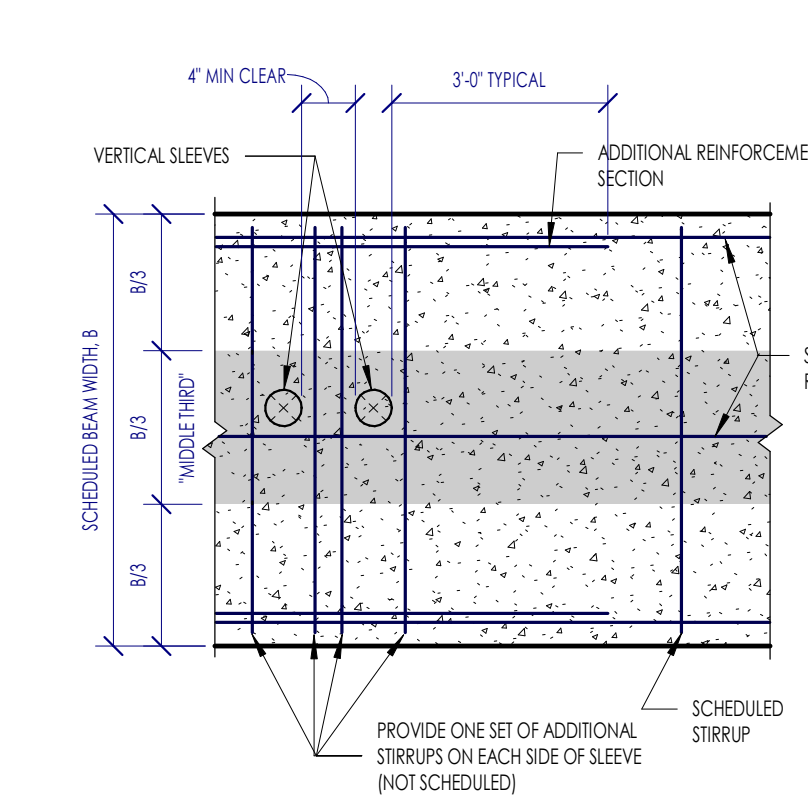

4B TYPICAL VERTICAL PENETRATION IN GRADE BEAM
NOT TO SCALE

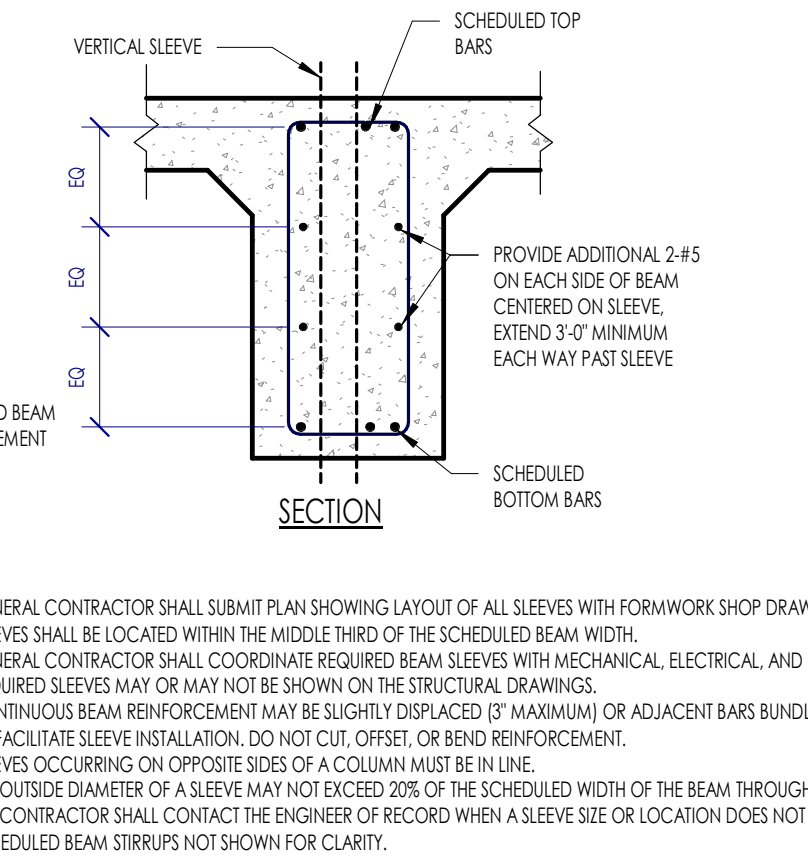

2B TYPICAL UTILITY TRENCH UNDER BUILDING PAD BENTONITE PLUG AT EXTERIOR BEAM.
NOT TO SCALE

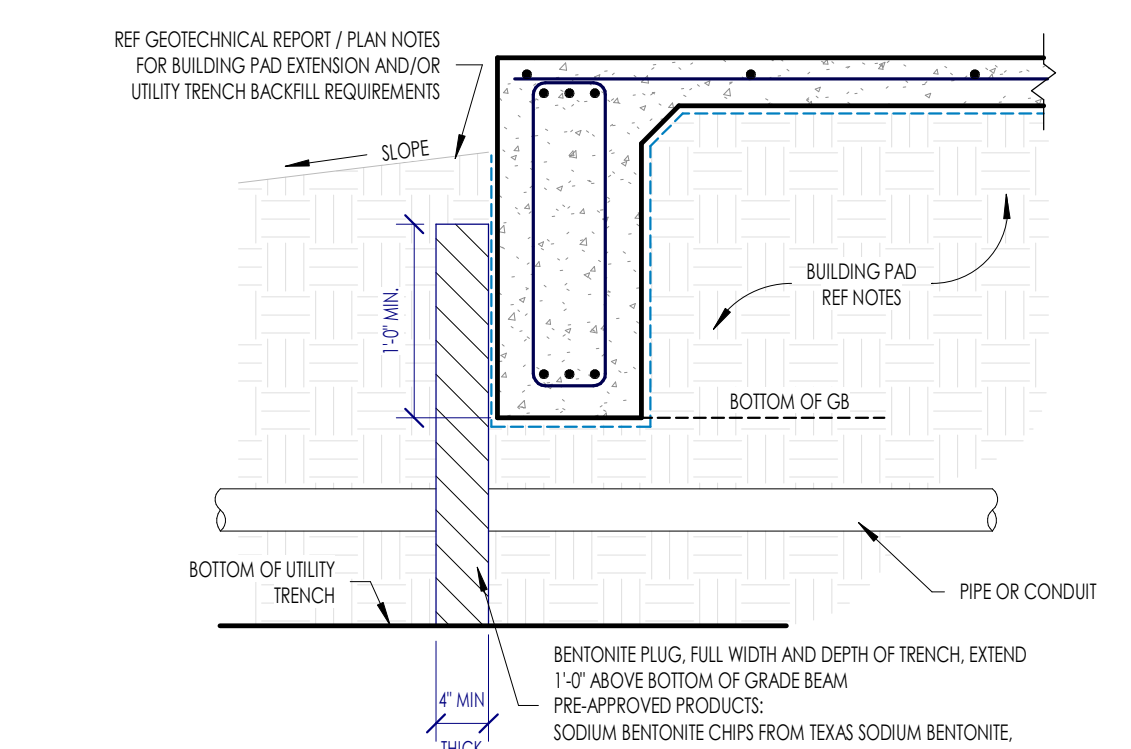

2B TYPICAL UTILITY TRENCH UNDER BUILDING PAD BENTONITE PLUG AT EXTERIOR BEAM.
NOT TO SCALE

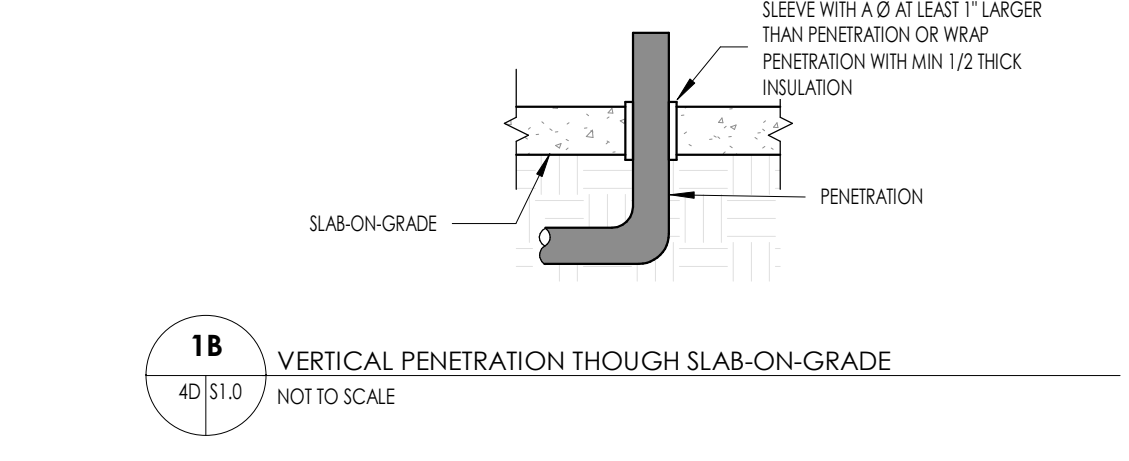

1B VERTICAL PENETRATION THROUGH SLAB-ON-GRADE
NOT TO SCALE

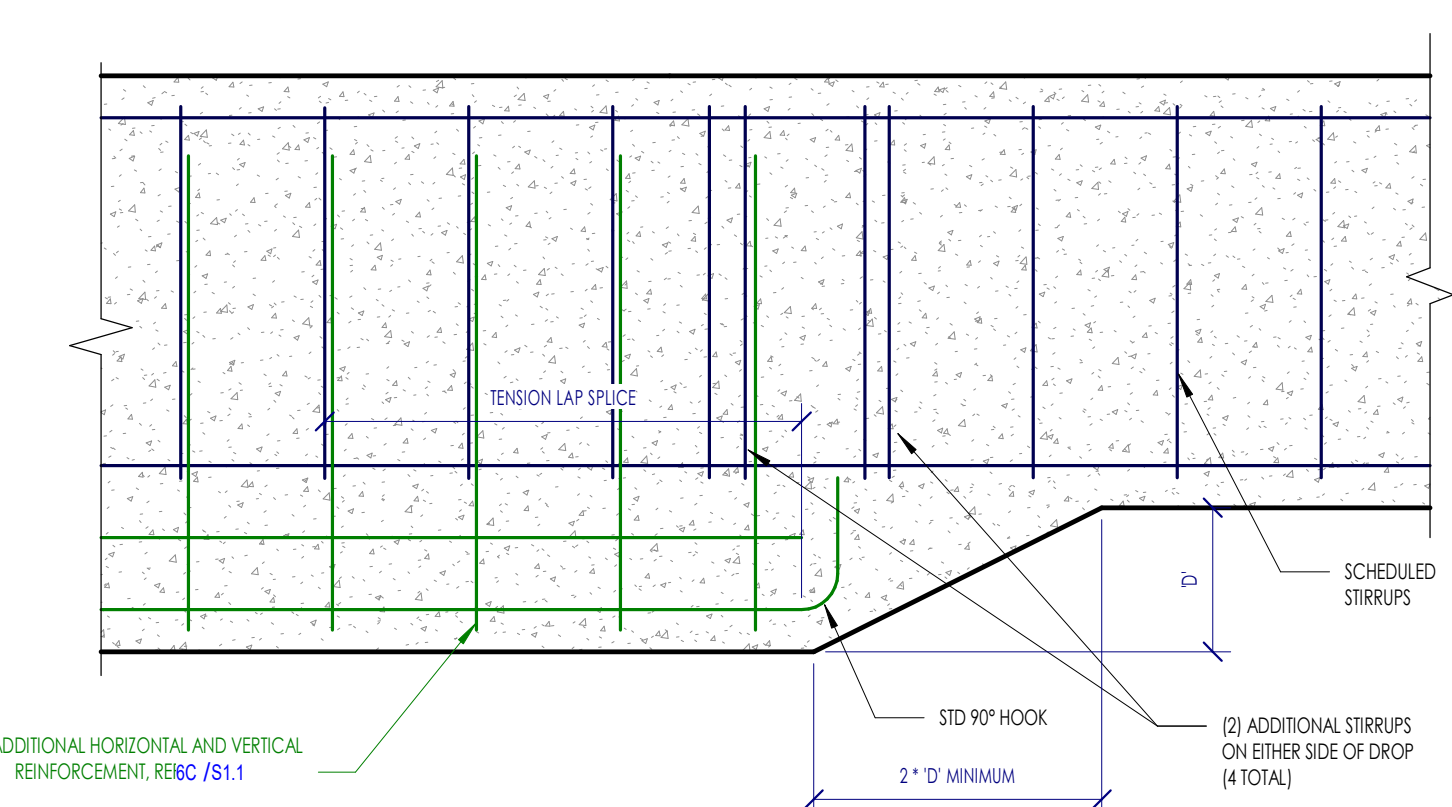

6A TYPICAL DROP TRANSITION IN GRADE BEAM - VERTICAL MOISTURE BARRIER
NOT TO SCALE

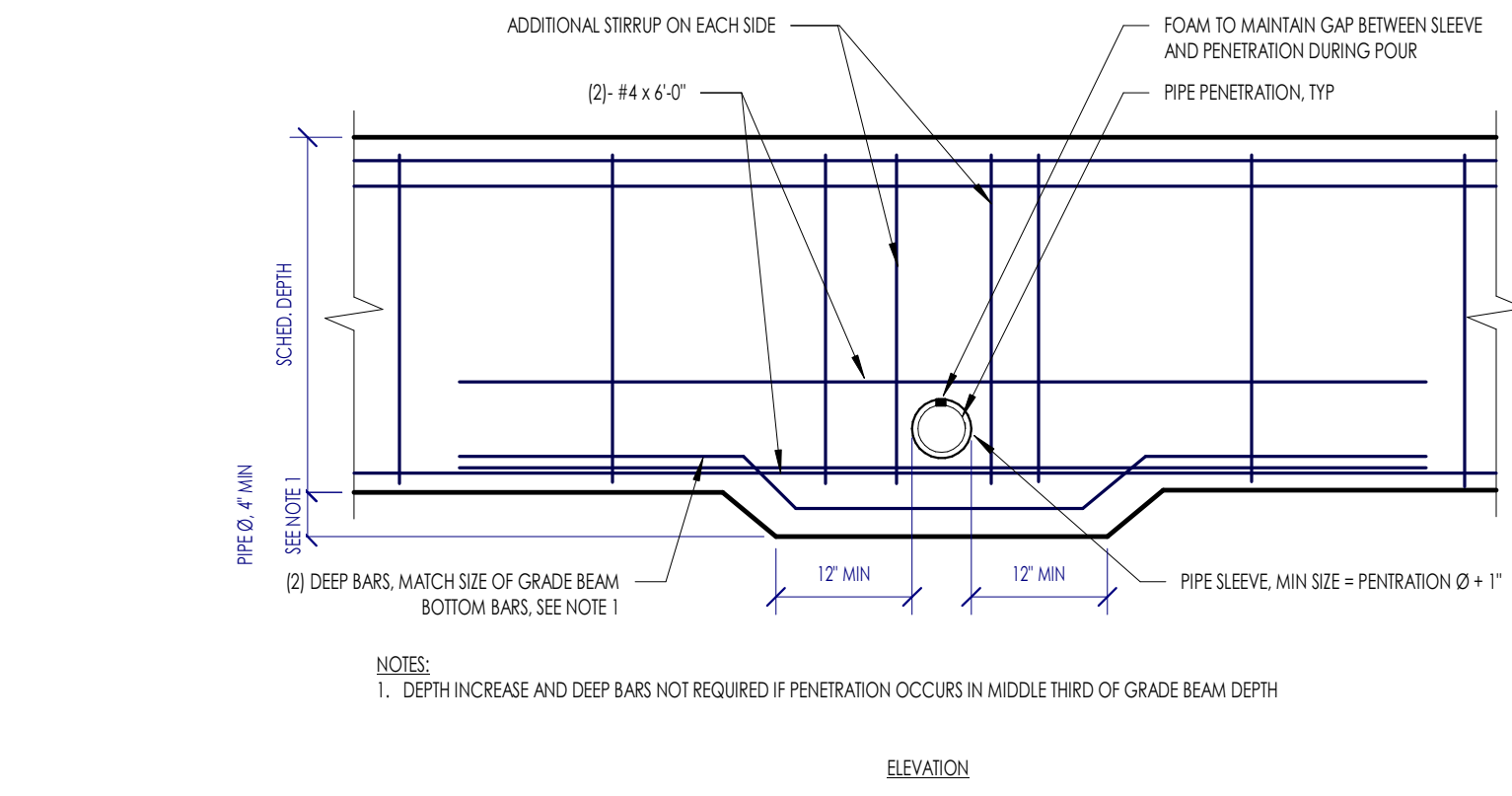

4A TYPICAL HORIZONTAL PENETRATION IN BEAM
NOT TO SCALE

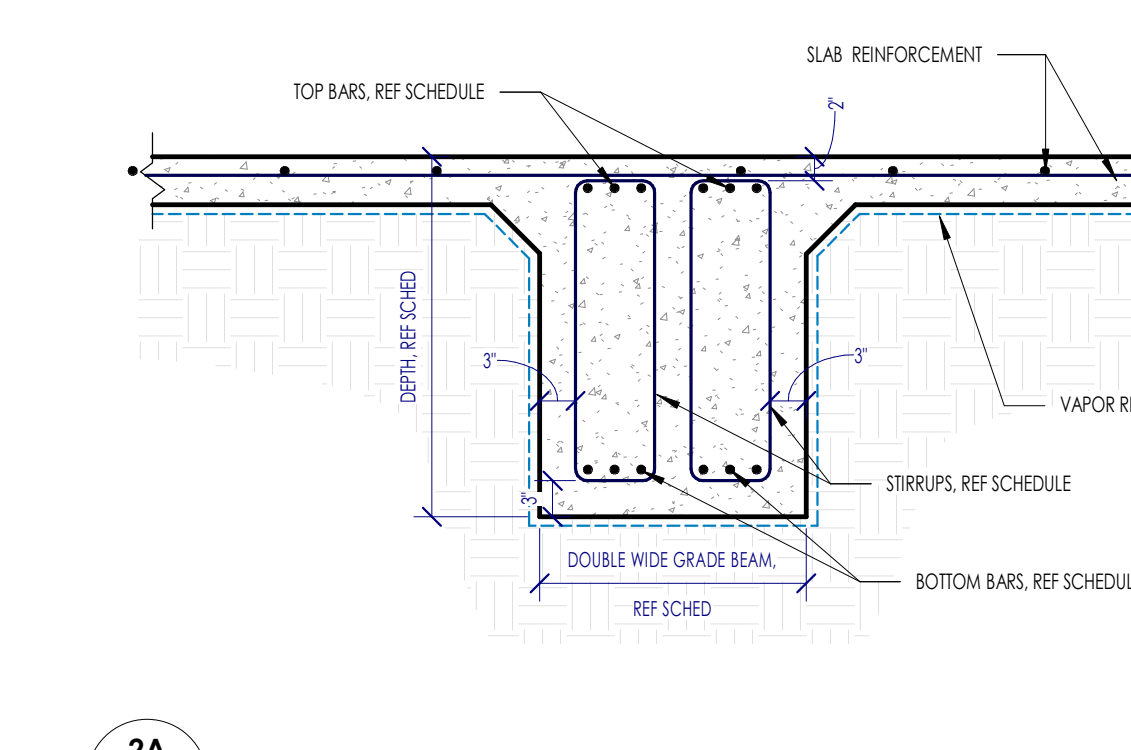

2A TYPICAL DOUBLE WIDE INTERIOR GRADE BEAM
NOT TO SCALE

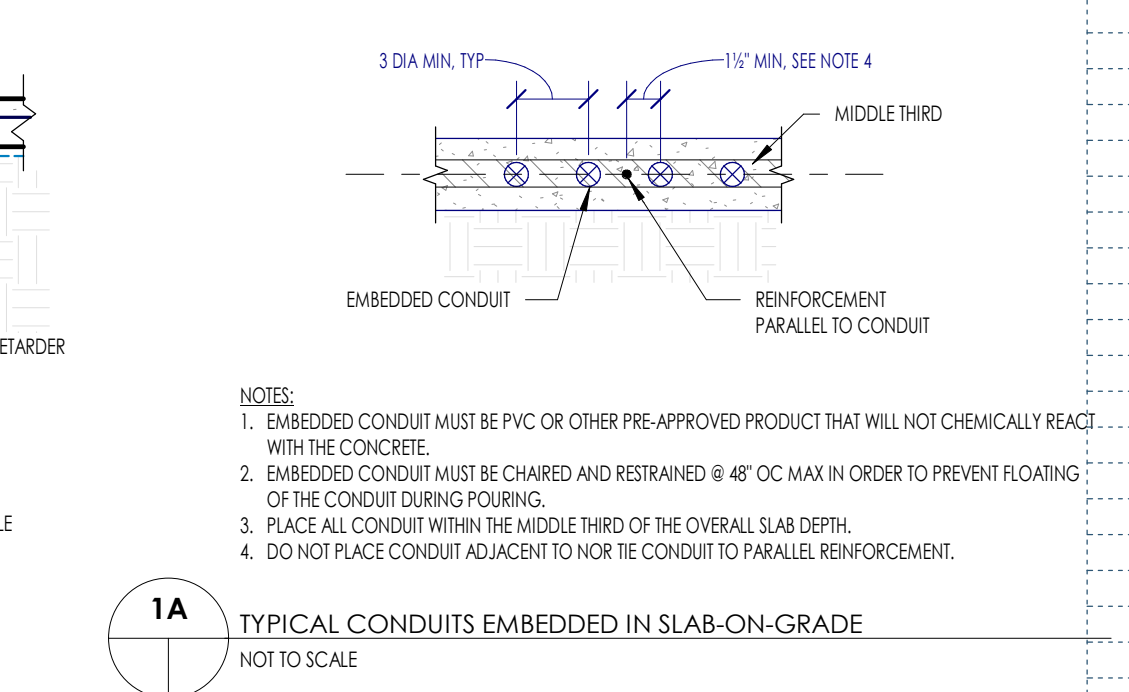

1A TYPICAL CONDUITS EMBEDDED IN SLAB-ON-GRADE
NOT TO SCALE

Date	Description
	REV. 1

